



Installing TimberTech Advanced PVC Deck & Fascia Boards with Top-Down Fastening Method



## What Makes TimberTech Advanced PVC so Simple to Install?



### EASE OF CUTTING

Cuts easier than capped composite and other alternative decking using the proper saw blade and cutting equipment.



### LIGHTWEIGHT

Timbertech Advanced PVC Decking weighs up to 30% less than competitive capped composite decking, making lifting and handling your deck boards easier.



### EASIER FASTENING / SIMILAR TO WOOD INSTALLATION PRACTICE

TimberTech Advanced PVC Decking is easily attached with screws and doesn't require predrilling like capped composite and other alternative and wood decking.

To access this information on the website click here. <https://www.timbertech.com/resources/deck-building/install-timbertech-azek-decking/>

#### DISCLAIMER

TimberTech® Advanced PVC and Composite decking should be installed using the same good building principals used to install wood or composite decking and in accordance with the local building codes and the Installation Guidelines found at the website below. AZEK Building Products LLC, its affiliates, successors, and assigns accepts no liability or responsibility for the improper installation of this product. TimberTech Advanced PVC and Composite decking may not be suitable for every application, and it is the sole responsibility of the installer to be sure that TimberTech Advanced PVC and Composite decking is fit for the intended use. Since all installations are unique, it is also the installer's responsibility to determine specific requirements for each Deck application. TimberTech recommends that all applications be reviewed by a licensed architect, engineer, or local building official before installation. Prior to your purchase, TimberTech also recommends that you review the full Installation Guidelines for more details regarding installation as well as information on care and maintenance, storage and handling, reference to warranty coverage, and other important product information. Installation Guidelines can be found at: <https://www.timbertech.com/resources/installation-help/>

## Design Assumptions

These instructions enable you to complete a **standard decking design** which includes a straight pattern with deck boards extending to the edges.

The fascia boards will be installed flush with the deck boards to cover the ends.

Your railing will be installed on top of the deck boards after the boards are installed.

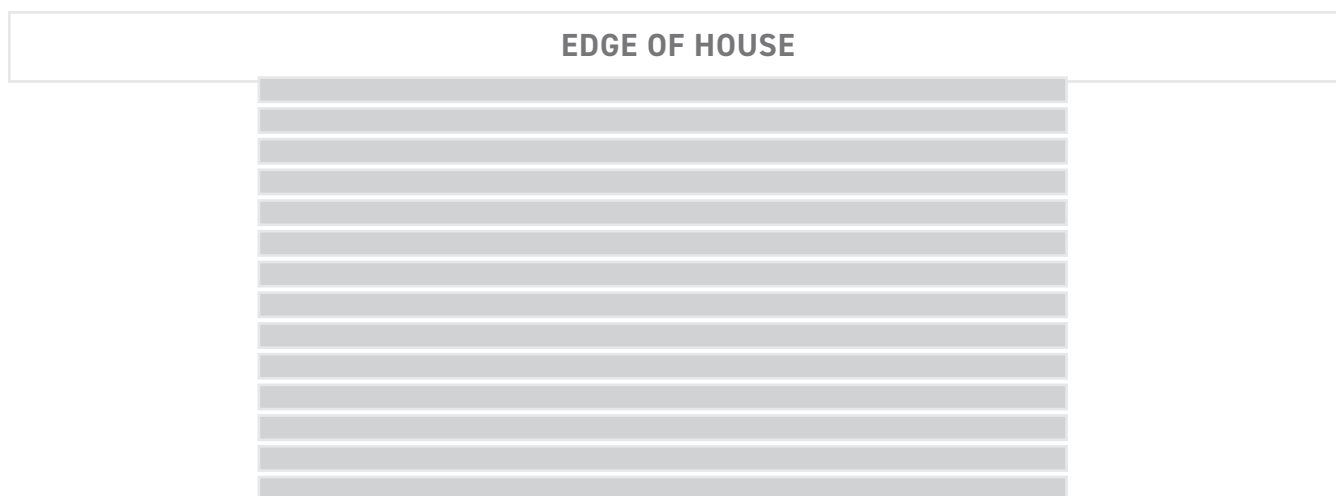

**DECK  
BOARD**



**FASCIA  
BOARD**



## Deck Components

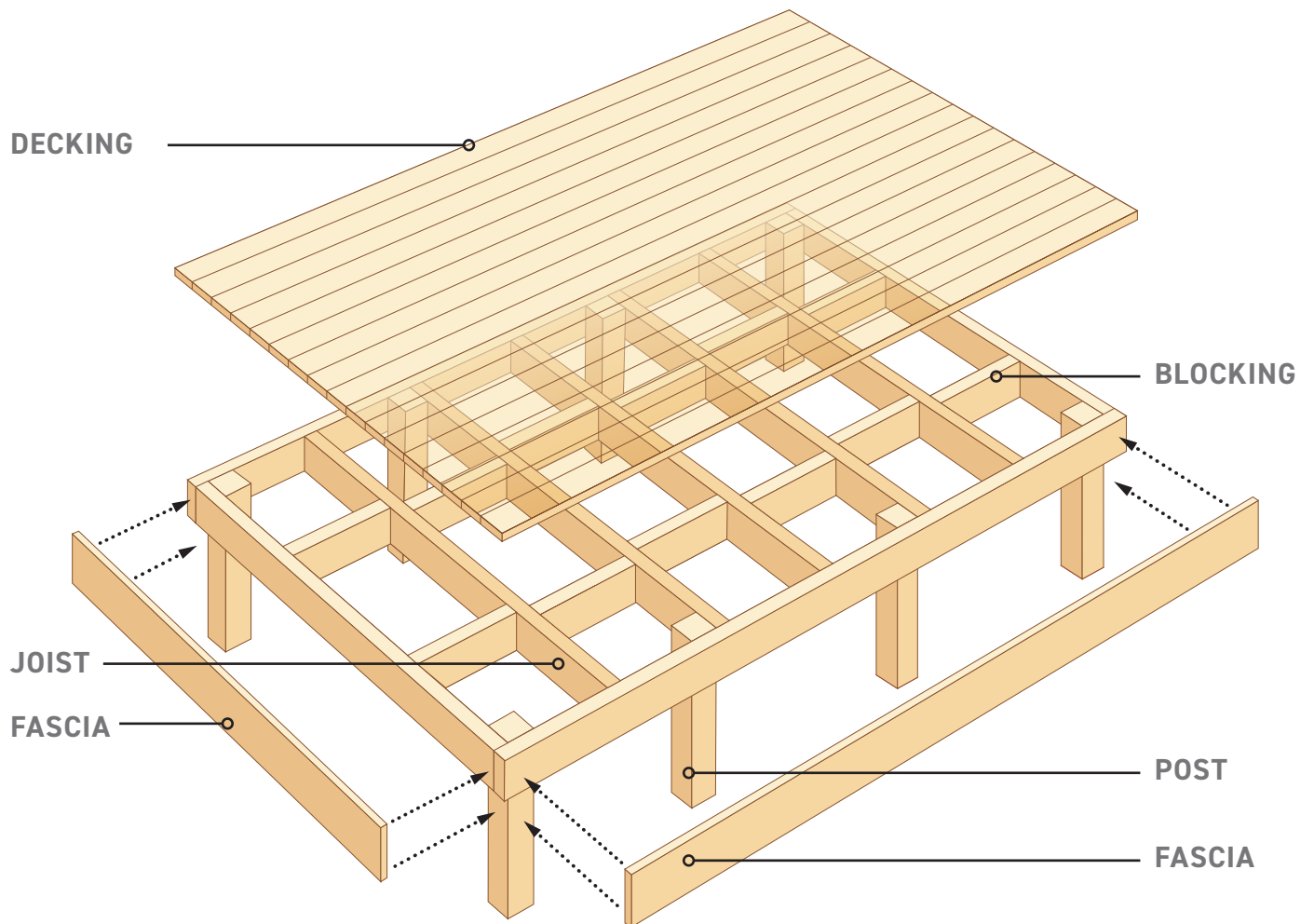

## Understanding TimberTech Advanced PVC Deck Material

1. It's best to keep the decking products stored in a cool, dry place, with original packaging on and/or covered..
2. TimberTech Advanced PVC Decking, like other alternative decking products, will encounter expansion and contraction during significant temperature changes which can occur between direct sunlight and shade/cloud cover.
3. Expansion/contraction/gapping, is most significant where extreme temperature change may exist.
4. For better results keep decking as cool as possible during attachment. Full direct sun exposure will increase board temperature and length. If attaching during high heat, larger gapping can be expected.
5. Best practice is to cut and fasten the deck boards as soon after cutting as possible. Do not cut and leave boards unattached for long periods of time, or over night, as the board length will change with temperature changes.
6. To further limit expansion, contraction, and gapping, follow the fastening instructions noted on the subsequent pages.
7. Avoid cutting and dragging ends of boards over each other as unwanted marks on deck surface could occur.



## Considerations and Tools



**ESTIMATED TIME:**

3 Hours\*



**RECOMMENDED MAN-POWER:**

1 - 2 People



**PRE-REQUISITE 1:** Deck plan (size, layout)

**PRE-REQUISITE 2:** Pre-existing framing attached to the house

**PRE-REQUISITE 3:** Proper joist spacing and blocking



**STEPS:**

1. Cutting Advanced PVC Deck Boards
2. Deck Fastening Best Practices
3. Installing Advanced PVC Deck Boards
4. Installing Advanced PVC Fascia Boards



**TOOLS NEEDED:**

- Safety glasses
- Power Miter Saw
- Jig Saw
- Cordless Driver
- Measuring Tape
- Carpenter Square
- Spacer/spacing tool
- Level



**FASTENERS:**

- HIGH quality fastener, specifically TimberTech TOPLoc for Advanced PVC Decking;
  - Alternatively, stainless steel screws with a minimum Screw Size: #7 can be used
  - Face screws @ min. length of 2 1/4"

Many other tools are available that can be used for installation. All tools should be used per applicable manufacturers' instructions.

\* Minimum, based on an average 16x20 deck.

Time may vary based on the installer's skillset and quality of substructure



**NOTE!** Do not move forward until you've confirmed your frame is structurally sound.

STEP ONE

Cutting Advanced PVC Deck Boards

**POWER MITER OR COMPOUND POWER MITER SAW**

For best results a miter saw with a fine-toothed, carbide-tipped finish trim blade (12" 100-tooth minimum or 10" 80-tooth minimum) works well for cutting



**FOR CUTTING AZEK BOARDS**

Electric Circular Saw 60 tooth fine finish blade



**FOR CUTTING AROUND RAIL POSTS AND OTHER OBSTRUCTIONS**

Jig Saw with fine tooth blade



**NOTE!** Do not use any cordless saws.



STEP ONE

## Cutting Advanced PVC Deck Boards

- For best results a miter saw with a fine-toothed, carbide-tipped finish trim blade (12"-100 tooth minimum) works well for cutting.
- As with any wood or alternative decking product always be sure to cut the factory ends of your board for a clean and square finish.
- Cut deck boards with the grain facing upward.
- Make sure face of the deck board is protected from the bottom of the saw during cutting with a circular saw or a jig saw.
- Cut boards one at a time.
- For best results cut boards before installing/ fastening or chipping can occur.
- Do not cut boards to length after fastening or chipping can occur.
- While using any saw, cut slowly or chipping can occur.
- As always, measure twice and cut once.
- Do not use cordless saws.



**NOTE!** Always wear the proper safety glasses (PPE)



STEP TWO

## Best Practices for Top Down Fastening

Due to the durability of Advanced PVC deck products, a high-quality fastener is recommended that meets the following specifications:

- **For best results use AZEK TopLoc color matched screws;** alternatively, stainless steel screws with a minimum Screw Size: #7 can be used
- Face screws to be a minimum length of 2 1/4"

*For salt water coastal applications, we suggest using the above minimum fastener requirements in 316 stainless steel.*

When fastening Advanced PVC deck with screws, NO PRE-DRILLING IS REQUIRED



T-TAP DRIVER BIT



CORDLESS DRILL



TOPLOC COLOR  
MATCHED SCREWS  
FOR ADVANCED PVC  
DECKING



**NOTE! Do not use nails to fasten TimberTech Advanced PVC deck boards.**

Avoid using flathead screws. Trim head screws typically provide a better result.

As always, you should try the fastener in a sample board before using on your deck.

AZEK does not recommend any fastener that is not explicitly stated in the TimberTech Decking and Installation Guide.

**STEP TWO**

## Best Practices for Top Down Fastening

### ALWAYS: 2 SCREWS AT ENDS, INTO JOISTS

Be sure to fasten ends of boards, splices, or abutments to building or structure securely into framing using 2 screws.



### FASTENER POSITION

Fasten  $\frac{3}{8}$ " from side edge and within  $\frac{1}{2}$ " from end of the board (remember: no pre-drilling required).



### SPACING BETWEEN BOARDS

Spacing between boards should be  $\frac{1}{8}$ "- $\frac{1}{4}$ ". The use of a spacer could add efficiency and help maintain proper spacing.

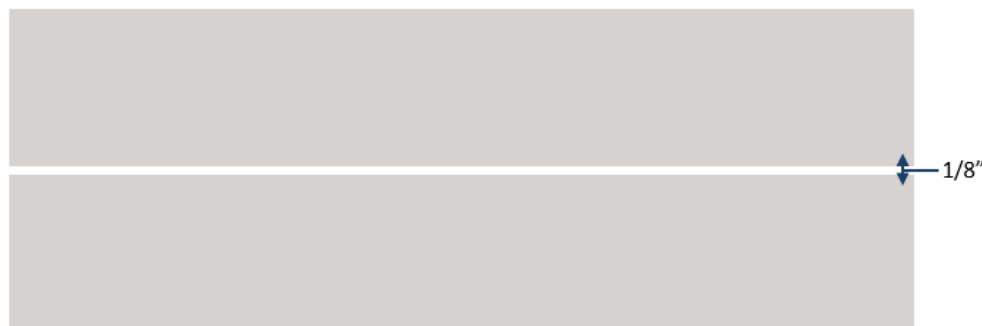

**STEP TWO**

Best Practices for Top Down Fastening

**BUTT JOINTS**

For butt joints, be sure to trim cut factory ends to ensure squareness. Be sure to keep butt joints tight. Do not leave a gap at butt joints, splices or miters.

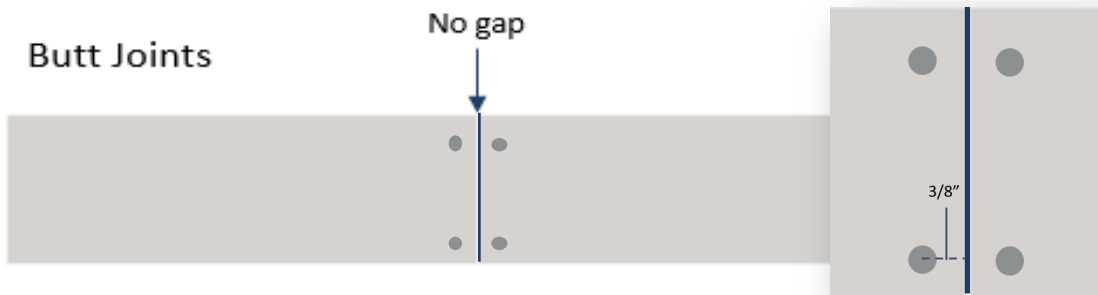

Install 2 screws within 1/2" from ends on each board



Do not scarf cut butt joints



**PROPER FASTENING**

Drive screws perpendicular to the deck board straight into the joist. Do not install screws at an angle.

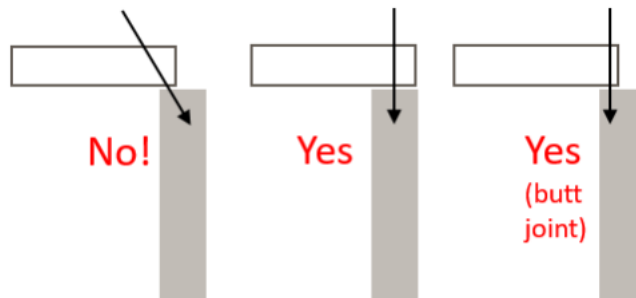

STEP THREE

## Installing Advanced PVC Deck Boards

### FOR THE FIRST BOARD

Start by fastening the first plank using 2 screws per joist and following the previous screw placement guidelines. Determine whether you need to start your decking at the house working out or from the outer end of deck working back toward the house.



**Check squareness to house and deck frame.** Measure from edge of deck board to outer edge of rim joist at each end and center of the deck board and verify the measurement is the same before fastening. Or, strike a chalk line on top of joists at desired position of the first board (measured back from outside rim joist on each end) and fasten first board along the line. It is a good idea to check these measurements periodically throughout the installation and make minor adjustments if needed.

STEP THREE

Installing Advanced PVC Deck Boards

Be sure to install 2 screws per joist on each deck board. Remember, drive screws **straight down** do not angle screws toward joist.

**Remember: Fasten within ½" from the end. Drive screw flush to surface. Do not overdrive.**

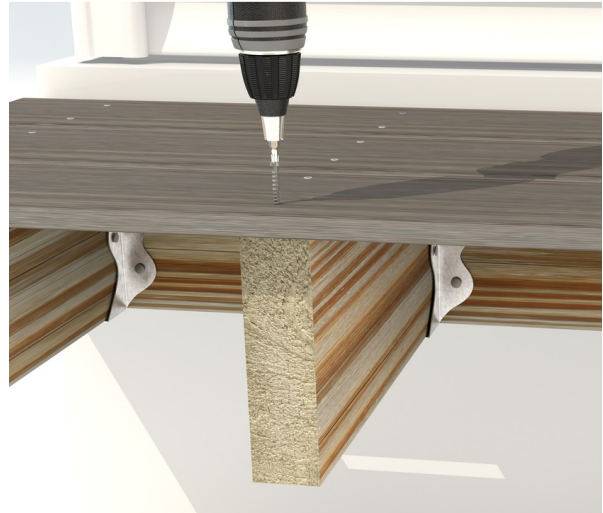
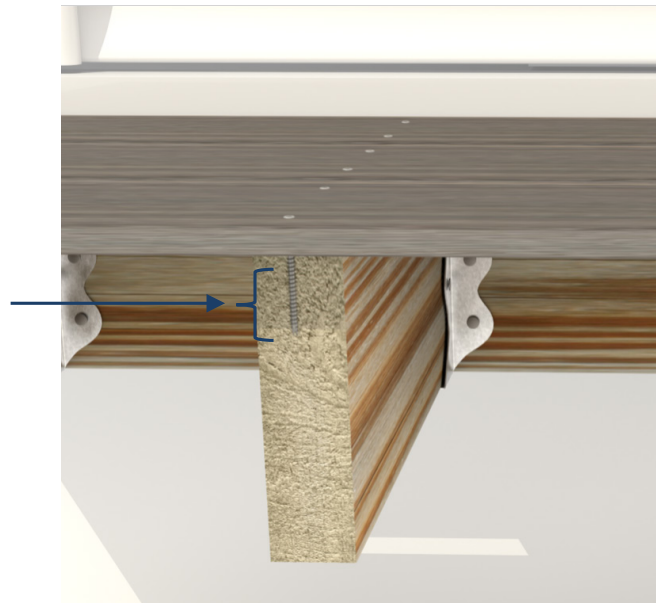

Illustration purposes only; boards must be affixed to joist every 16" max.

Be sure that screws are driven to a minimum depth of 1 1/4" into solid wood framing below the bottom of the Advanced PVC Deck Board. This will enhance holding power and uplift resistance.

1 1/4"  
Min.  
Into  
Joist





**STEP THREE**

## Installing Advanced PVC Deck Boards

Make sure to drive the screws until they're flush to slightly below surface of the deck board. Use the proper bit and drive screw at slower speed until it is flush to slightly below the deck surface.

**Incorrect**  
Screw head sits above deck board

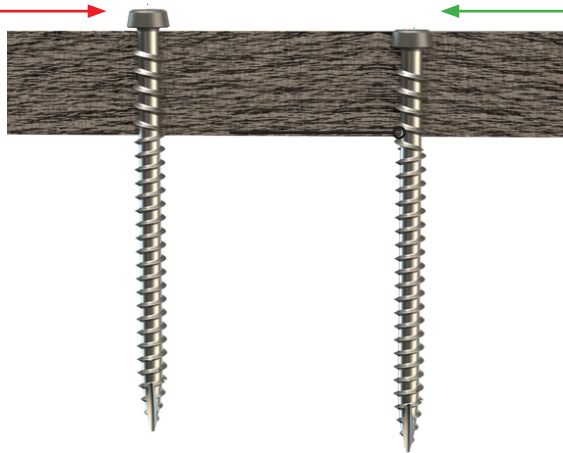

**Correct**  
Drive screw flush to slightly below deck board

### ENSURE PROPER SPACING

Recommendation for 1/8" - 1/4" gapping/ space for proper drainage.

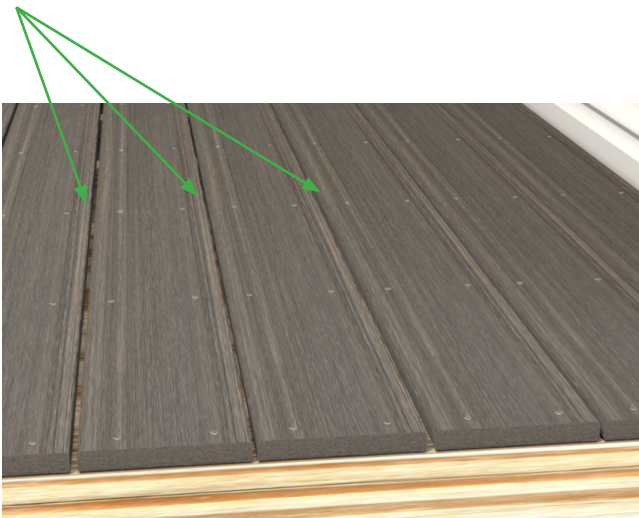

### SPACERS

Using spacers help insure a uniform amount of space between each board. Spacers available on [TimberTech.com](https://www.timbertech.com)

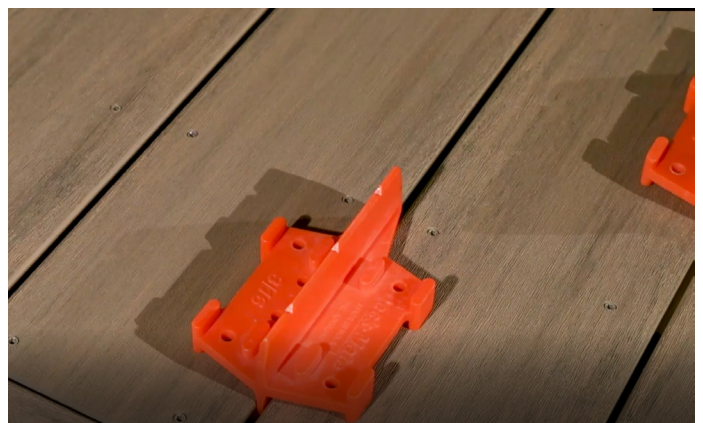

STEP FOUR

## Installing Advanced PVC Fascia Boards

Due to the durability of Advanced PVC fascia products, a high-quality fastener is recommended that meets the following specifications:

- **For best results use Advanced PVC TopLoc for fascia color matched screws;** alternatively, stainless steel screws with a minimum Screw Size: #7 can be used
- Face screws to be a minimum length of 1 ¾"

*For salt water coastal applications, we suggest using the above minimum fastener requirements in 316 stainless steel.*

When fastening Advanced PVC fascia with screws, NO PRE-DRILLING IS REQUIRED



T-TAP DRIVER BIT



CORDLESS DRILL



TOPLOC COLOR  
MATCHED SCREWS  
FOR ADVANCED PVC  
FASCIA



**NOTE! Do not use nails to fasten TimberTech Advanced PVC deck boards.**

Avoid using flathead screws. Trim head screws typically provide a better result. As always, you should try the fastener in a sample board before using on your deck. AZEK does not recommend any fastener that is not explicitly stated in the TimberTech Decking and Installation Guide.

STEP FOUR

Installing Advanced PVC Fascia Boards



**RECOMMENDED  
MAN-POWER:**  
1 - 2 People\*



**TOOLS NEEDED:**

- Power miter saw
- Circular saw or table saw
- Quality exterior grade construction adhesive
- TopLoc Fascia screws
- Drill
- T-tap driver bit
- Level



\* Minimum, based on an average 16x20 deck.  
Time may vary based on the installer's skillset and quality of substructure

**STEP FOUR**

Installing Advanced PVC Fascia Boards

Measure the length of the outside rim joist to determine length of Advanced PVC fascia board needed.

It may be necessary to rip cut the TimberTech Advanced PVC fascia board to fit the outside rim board of the deck. A slight (up to 1/2") overhang is permitted with the goal being to hide the wood rim joist.

Rip cut needed

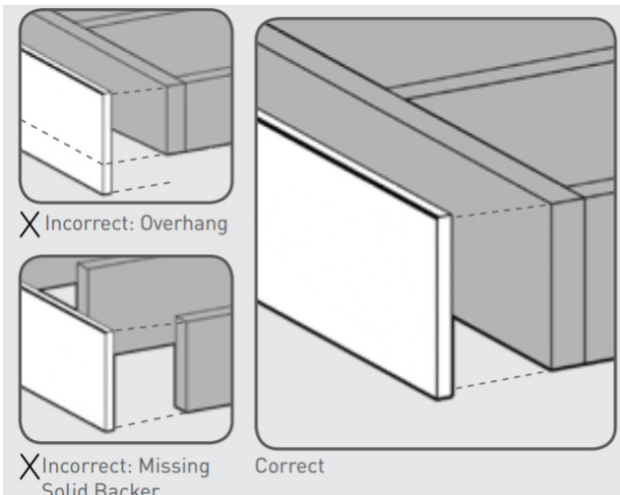
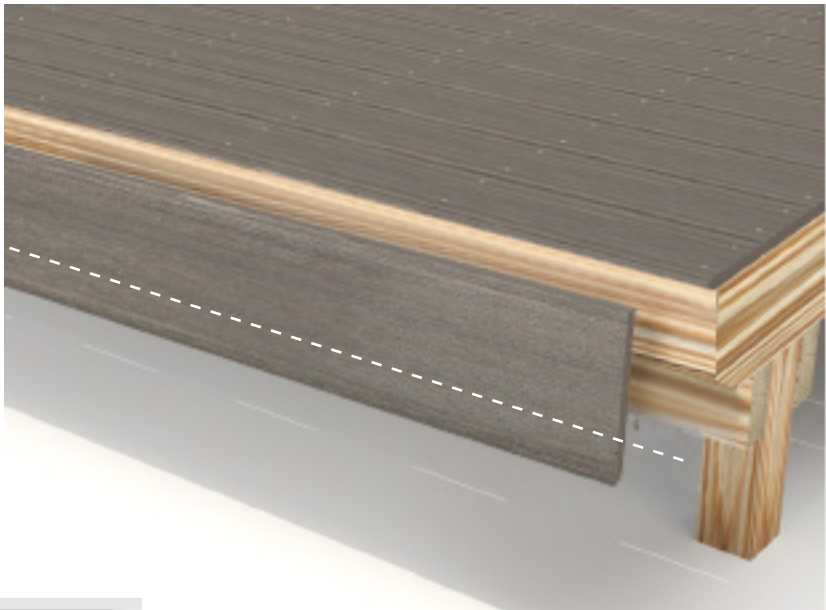

If fascia or rim board does require 'ripping down' - "Make sure that the cut edge is positioned down/not up exposing the core material - place factory edge/cap stock edge up and flush with walking surface"



STEP FOUR

Installing Advanced PVC Fascia Boards

- 1) Apply a good quality exterior grade construction adhesive to the back (smooth) surface of the board. Do not get adhesive on the grained surface of the rim joist or decking.

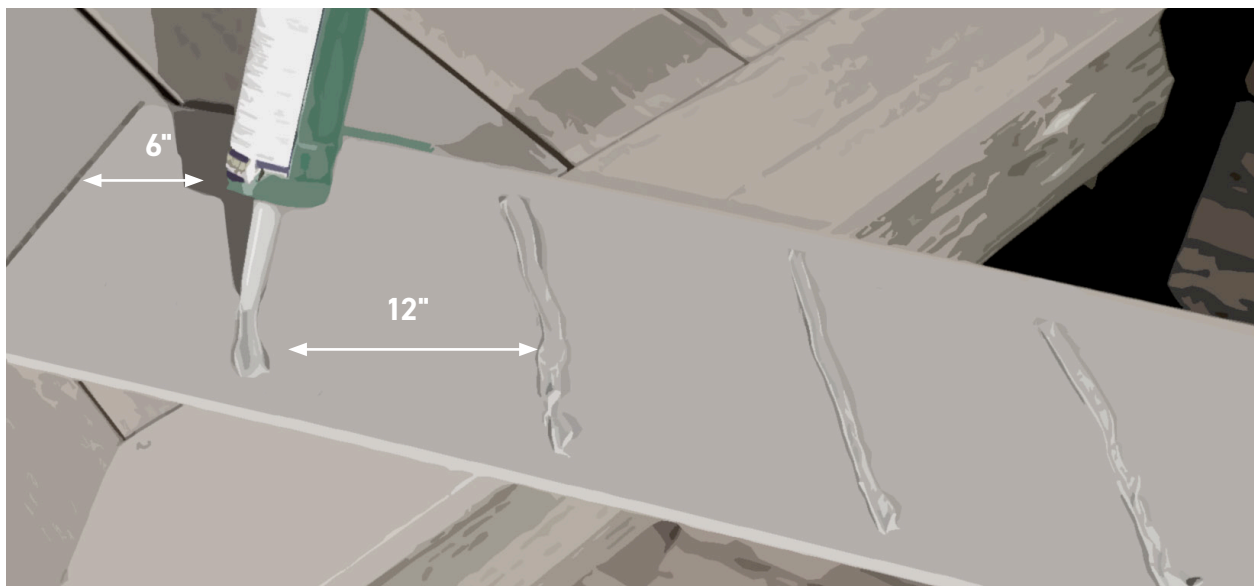

- 2) Position the board so it is flush with the top of the deck boards

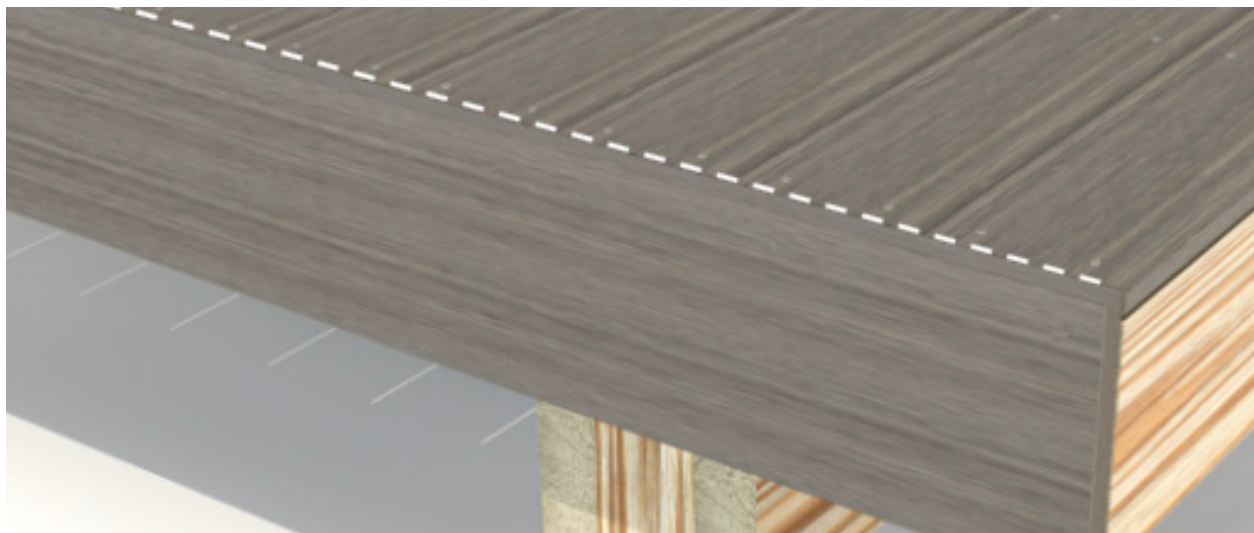



STEP FOUR

Installing Advanced PVC Fascia Boards

- 3) Install top and bottom screws at  $\frac{1}{2}$ " from top and bottom edge of the solid wood rim joist. Drive screws into the board every 12".

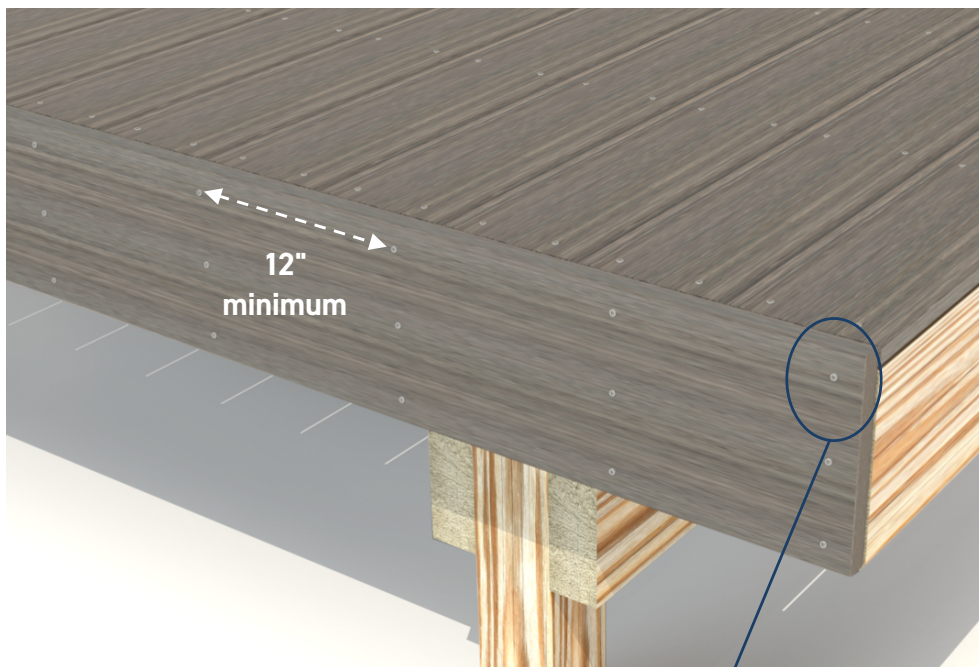

Fasten within  $\frac{1}{2}$ " from the edge



Install three (3) screws from top to bottom with top and bottom screws positioned no more than  $\frac{1}{2}$ " from the edge as shown below. The third screw should be approximately centered in the board. Repeat this configuration every 12".